



GLASS EXPANSION

Quality By Design

Nebulizer Resource Guide

Issue 1

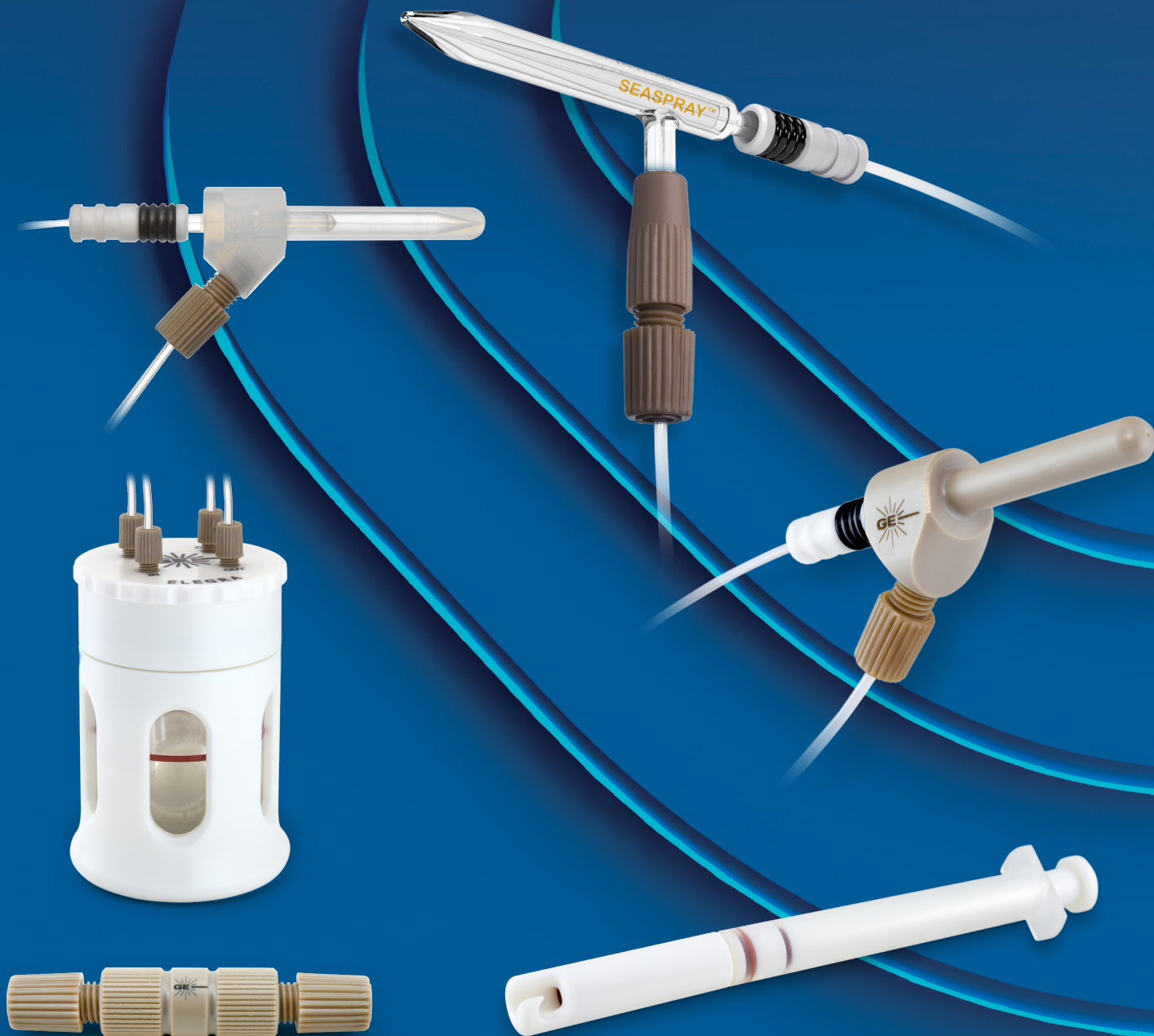

Introduction to Glass Expansion Nebulizers

Nebulizer Types	1
Understanding Nebulizer Part Numbers	1
Understanding Nebulizer Operating Conditions	2

Learn About Glass Expansion Nebulizers

DC Nebulizers	4
Quartz SeaSpray DC Nebulizer	4
DC Nebulizer Gas Fitting Connectors	5
U- Series Glass Concentric Nebulizers.....	6
Nexus Universal Nebulizer Connection Kit.....	6

Nebulizers by Type

Glass Concentric Nebulizers

SeaSpray Nebulizer	7
MicroMist Nebulizer.....	7
Slurry Nebulizer	8
Conikal Nebulizer.....	8
HE MicroMist Nebulizer	9

Inert Nebulizers

DuraMist Nebulizer	9
OpalMist Nebulizer	10
Ceramic VeeSpray Nebulizer	10

Nebulizer Selection Guide

Aqueous Solutions without HF for ICP-OES.....	11
Aqueous Solutions without HF for ICP-MS	11
Solutions Containing HF	12
Organic Solutions.....	12

Nebulizer Accessories – Maintenance

TruFlo Sample Monitor	13
Eluo Nebulizer Cleaning Tool	13
Guardian In-Line Sample Filter	14
Guardian In-Line Non-Return Gas Filter.....	14
Trident CT In-Line Reagent Additions Kits.....	15
Guardian Autosampler Probe	16
Elegra Argon Humidifier	17
Magnifier Inspection Tool.....	17

Nebulizer Troubleshooting Guide

Nebulizer Maintenance Procedure

Care of Nebulizers	20
Recommended Cleaning Procedure	20

Nebulizer Fittings & Connectors

DC Nebulizer Gas Fitting Connectors	21
Nexus Universal Nebulizer Connection Kit	21
Ezylok Kit for Nebulizer Gas Side Arm.....	21
Tubing Connector	22
UniFit Connectors	22
Sample Tubing	22
UniFit Flangeless Connectors for High Throughput Valves	23

Introduction to Glass Expansion Nebulizers

The nebulizer is a critical component of your ICP sample introduction system, so why not opt for the highest quality? Glass Expansion has been manufacturing ICP nebulizers since the early 1980s and continually updates nebulizer designs to improve performance and ease of use. Our proprietary designs include a thick walled VitriCone capillary, UniFit sample line connector and the Direct Connect (DC) product line.

Whether your ICP laboratory is analyzing clean aqueous samples, samples containing HF and/or high dissolved salts, or volatile organic solvents; Glass Expansion has a nebulizer to suit your needs. Learn about the performance advantages and overall difference in construction quality that a Glass Expansion nebulizer can provide your ICP laboratory.

Nebulizer Types

Nebulizer	Dead Volume V_0 (μ L)	TDS (%)	Particulates (μ m)	HF	Precision	Purity	Material
SeaSpray™	4	20	*200	No	High	Good	Glass
MicroMist™	1	15	*100	No	High	Good	Glass
Conikal™	5	5	210	No	High	Good	Glass
Slurry™	11	1	280	No	High	Good	Glass
Quartz SeaSpray™	5	20	210	No	High	Excellent	Quartz
OpalMist™	4	15	*200	Yes	High	Excellent	PFA
DuraMist™	4	30	*200	Yes	High	Good	PEEK
VeeSpray™	100	30	550	Yes	Moderate	Good	Ceramic

*Particle Size Tolerance (μ m): 200 = USS1, USS2, DM2, PFA2; 140 = PFA1, DM1; 100 = USS04, PFA04, DM04; 90 = UM02, UM01, UM005; 70 = PFA005, PFA01, PFA02

Understanding Nebulizer Part Numbers



Example: MicroMist DC Nebulizer
0.4mL/min

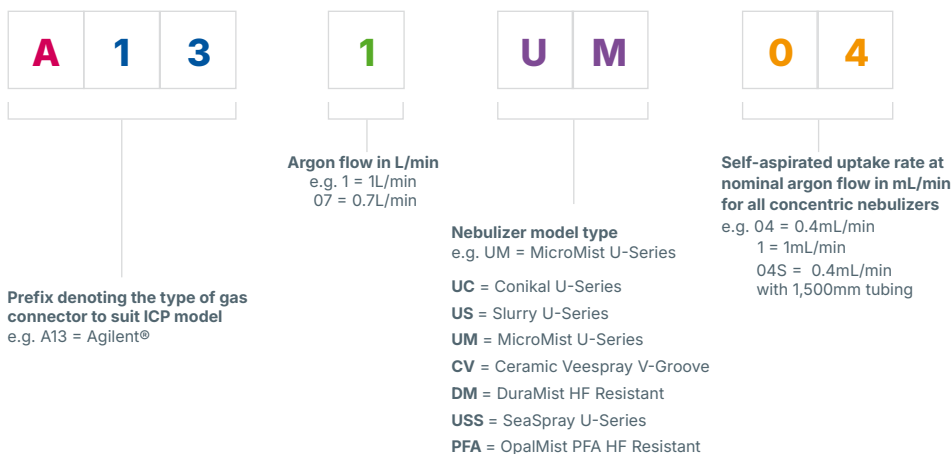

Understanding Nebulizer Operating Conditions

Fully understanding the nomenclature of Glass Expansion's nebulizer part numbers is crucial for selecting the right model and operating conditions.

All of Glass Expansion's concentric nebulizer designs will self-aspirate at a nominal argon gas flow rate, except for a few specialized MicroMist High-Efficiency (HE) models. The self-aspiration rate is indicated by the nebulizer part number, as explained in the previous section. This rate is standardized using Deionized (DI) water; however, the actual uptake depends on the viscosity of the sample, the length and inner diameter (ID) of the nebulizer sample tubing, the sample height, and the nebulizer gas flow rate.

Four nebulizer examples highlighting the most common sample flow rates used in ICP-OES and ICP-MS methods are: 2.0 mL/min SeaSpray, 4.0 mL/min Slurry, 0.4 mL/min MicroMist, and the 1.0mL/min DuraMist. The four tables below show approximate percentage reduction in water uptake measured using the TruFlo Sample Monitor (see details on Page 13) at our standard calibration height of 5 cm above the water level, using different internal diameters of nebulizer sample tubing. The highlighted row indicates the standard packaged configuration of that particular nebulizer model, while optional UniFit sample connectors are available on page 22.

SeaSpray Nebulizer (P/N A13-07-USS2) operated at 0.7 L/min Argon (40 psi)		
Tubing ID (mm)	Uptake Reading (µL/min - DI Water)	Decrease from Nominal
0.75	2050	
0.50	1350	-34%
0.25	150	-93%
0.18	80	-96%

Slurry Nebulizer (P/N A13-07-US6) operated at 0.7 L/min Argon (40 psi)		
Tubing ID (mm)	Uptake Reading (µL/min - DI Water)	Decrease from Nominal
0.75	2859	
0.50	1288	-55%
0.25	101	-96%
0.18	70	-98%

MicroMist Nebulizer (P/N A13-1-UM04) operated at 1.0 L/min Argon (40 psi)		
Tubing ID (mm)	Uptake Reading (µL/min - DI Water)	Decrease from Nominal
0.50	419	
0.25	123	-71%
0.18	84	-80%

DuraMist Nebulizer (P/N A13-07-DM1) operated at 0.7 L/min Argon (40 psi)		
Tubing ID (mm)	Uptake Reading (µL/min - DI Water)	Decrease from Nominal
0.50	904	
0.25	156	-83%
0.18	89	-90%

*Highlighted is the standard UniFit ID packaged with the nebulizer.

**4 mL/min self-aspiration uptake

The most common method for sample delivery with modern ICP instruments is using a peristaltic pump or a high-precision syringe drive. When selecting a nebulizer model, choose one that matches your sample flow rate range. Our top models include the 2.0 mL/min and 1.0 mL/min options for ICP-OES and the 0.4 mL/min for ICP-MS. Sample flow rates below 100 µL/min are generally used for High Resolution ICP-MS (HR-ICP-MS) and Multi Collector ICP-MS (MC-ICP-MS). If not, it is likely a specialized application needing a low-flow MicroMist, such as models "-UM01" or "-UM005." Nebulizers with these ultra-low flow rates often require self-aspiration or a high-precision syringe drive to prevent pulsations from the peristaltic pump, which are more noticeable at ultra-low sample flow rates.

The recommended sample flow rate range for each nebulizer example is shown in the table on the right. These recommended ranges apply to all our 2.0, 1.0, and 0.4 mL/min concentric nebulizer models. It is acceptable to rinse and uptake at much higher flow rates for short periods, but it's important to allow enough stabilization time for the flow rate and nebulization efficiency to return to normal measurement conditions.

Nebulizer Model	Recommended Sample Flow Range
A13-07-USS2	0.4 to 3mL/min
A13-07-DM1	0.4 to 2mL/min
A13-1-UM04	0.05 to 1mL/min

Nebulizer gas flow is also very important for optimal nebulizer performance; the best nebulization efficiency occurs at a gas flow rate close to the specified value, as shown in the nebulizer product number. Most of Glass Expansion's nebulizers are designed to operate at an optimal back pressure of 40 psi, which is reached when the argon flow is set to the specified L/min indicated in the part number.

Learn About Glass Expansion Nebulizers

All Glass Expansion concentric nebulizers use the unique VitriCone™ construction delivering the best possible precision. Other manufacturers heat and draw a thin fragile capillary from glass tubing to create the internal capillary. This process is prone to a number of problems including inconsistent diameters, an increase in the porosity of the glass, and harmonic vibrations from the flow of argon, all of which can degrade performance and lifetime.

Glass Expansion is the only manufacturer that takes thick walled precision-bore tubing and machines the outside to a uniform aerodynamic shape. This guarantees a uniform sample channel, assuring tolerance to nasty samples and excellent reproducibility. Also, note the zero dead volume UniFit sample line fitting, also unique to GE.

- **Resists blockage:** The sample channel is uniform from the entry point to the tip, so there is nowhere for particulates to be trapped.
- **Simple to use:** Our proprietary UniFit connector slides easily over the sample arm and creates an excellent seal.
- **Full length VitriCone construction:** With the VitriCone design, the sample channel is formed from a heavy-walled glass capillary machined to very tight tolerances.

Industry Leaders

- No other manufacturer can match the precision and reproducibility of the **'VitriCone' construction**, making it the most robust and dimensionally reproducible concentric nebulizer available.
- The Global Standard in Nebulizer Innovation

Manufacturing Tolerance

- Controlled overall length precision
- Shell Diameter
- Full length precision bore capillary
- Precision formed jet nozzle
- Depth positioning stop

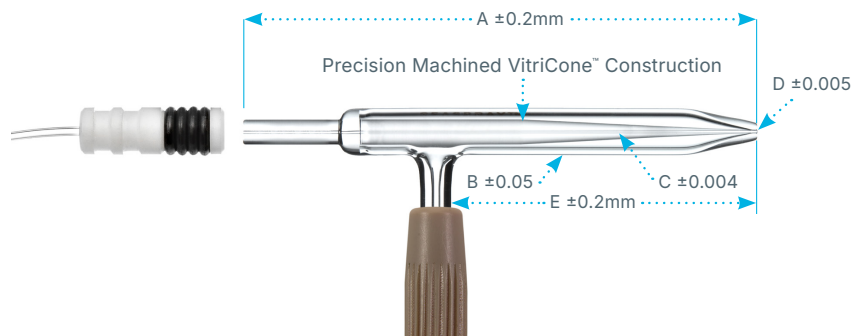

GE Value Proposition – Highest Value for Money

- **Reproducibility** – Never a need to re-optimize the parameters when new component installed
 - * Saves time
 - * Essential for experiments
- **Long life** – High quality and innovative design reduce wear
 - * Saves money
 - * Reduces down-time
- **Dependability** – over 40 years of experience
 - * Applications support saves time experimenting

GE Value Proposition – Nebulizer example

- Reproducible production eliminates optimization time.
- Precision-bore capillary design reduces clogging and delivers ultra-low dead volume for rapid washout.

DC Nebulizers

The DC (Direct Connection) nebulizer has a UniFit sample connector which slides easily over the sample arm and an argon connector configured to connect directly to your ICP.

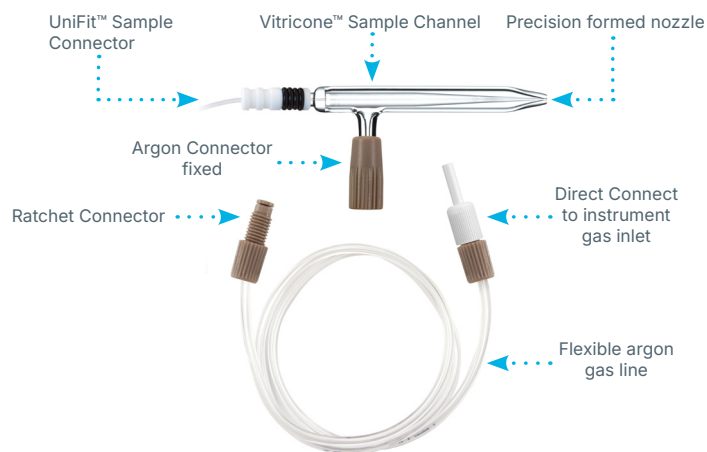

Benefits:

- Made from constant bore thick walled tubing (VitriCone)
- Machined exterior provides proper aerodynamics
- Zero dead volume sample connection
- Inert metal-free argon connector
- ICP model specific Direct Connect (DC) argon line
- Ratchet fitting ensures leak-free gas connection
- Direct plug-in gas line connection to instrument
- Lowest internal dead volume for rapid washout

DC versions of the SeaSpray, MicroMist, Conikal, Slurry, DuraMist, OpalMist and VeeSpray nebulizers are available to suit the most common models of ICP-OES and ICP-MS.

The DC nebulizer part number has a prefix specific to each type of gas connector. For example, the prefix "A13-" denotes a connector for the Agilent® 5000 ICP-OES Series, so part number A13-07-USS2 is a SeaSpray nebulizer configured for direct connection to the Agilent® 5000 Series.

In addition to these unique benefits, the DC nebulizer shares the following benefits with the U-Series nebulizer:

- **Resists blockage:** The sample channel is uniform from the entry point to the tip, so there is nowhere for particulates to be trapped.
- **Fast washout:** Precision bore sample channel maintains lowest dead volume, providing the fastest possible washout.
- **Simple to use:** Our innovative UniFit connector slides easily over the sample arm and creates an excellent seal.
- **Full length VitriCone construction:** With the VitriCone design, the sample channel is constructed from heavy wall precision bore capillary which is machined to very high tolerances, ensuring a uniform sample channel that resists clogging and provides high precision.

Quartz SeaSpray DC Nebulizer

The Quartz SeaSpray DC nebulizer is made from ultra pure quartz and offers outstanding nebulization efficiency for trace level analyses. It offers freedom from clogging while nebulizing solutions to the limit of solubility of most mineral salts, and conferring significant sensitivity gains. It is specifically designed for ultra trace level analysis.



DC Nebulizer Gas Fitting Connectors

Manufacturer	Model	P/N Prefix	Gas Line Included	
Agilent Technologies®	4100/4200	MP11-	70-803-0969	
Agilent Technologies®	Vista/700-ES	A11-	70-803-0969	
Agilent Technologies®	7700/7800/7850/7900/8800/8900	A13-	70-803-1105	
Agilent Technologies®	5000 Series	A13-	70-803-1105	
Analytik Jena®	ICP-MS	A61-	70-803-2002	
Analytik Jena®	ICP-OES	A13-	70-803-1105	
Horiba® Jobin Yvon	All Models	A13-	70-803-1105	
Nu Instruments	ICP-MS	A51-	70-803-1858	
Nu Instruments	TOF-ICP-MS	A52-	70-803-2044	
PerkinElmer®	ICP-OES	A21-	70-803-1070	
PerkinElmer®	Elan/NexION 300/350	A22-	70-803-1049	
PerkinElmer®	NexION 1000, 1100, 2000, 2200, 5000	A23-	70-803-1449	
Shimadzu®	All Models	A41-	70-803-1311	
Spectro™	All Models	A21-	70-803-1070	
Standard BioTools™ (Fluidigm)	Helios	A21-	70-803-1070	
Thermo Scientific™	PRO, 6000/7000, Q/RQ/TQ/RQ Plus, X-Series & Neoma	A31-	70-803-1105	
Thermo Scientific™	MX Series	A13-	70-803-1105	
Thermo Scientific™	Neptune	A11-	70-803-0969	

U-Series Glass Concentric Nebulizers

SeaSpray, MicroMist, Conikal and Slurry U-Series nebulizers are available to suit all common models of ICP-OES and ICP-MS. Each U-Series nebulizer is supplied with a UniFit sample connector.

U-Series nebulizers can be identified by the letter 'U' in the part number, eg. ARG-07-USS2 or ARG-1-UM04.

The difference between the U series nebulizer and DC nebulizers lies solely in the argon gas connector. The U series nebulizer features the EzyLok argon connector, while DC nebulizers utilize advanced direct connect (DC) argon fittings. The inert, metal-free DC argon gas fittings, with built-in torque control, ensure reliable, reproducible, and leak-free connections, keeping analyses contaminant-free. Large, soft-walled tubing prevents kinks and fatigue common with rigid capillaries.



Nexus™ Universal Nebulizer Connection Kit

The Nexus™ Universal Connection Kit is a one-size-fits-all nebulizer connection kit which enables you to use any of Glass Expansion's industry-leading concentric nebulizers* with the sample introduction configuration of your choice, including switching valves, chromatographs (LC, HPLC, IC, etc.), and other high-performance accessories:

- **Switching Valves:** Simple and reliable custom-length connections to all high-throughput valve or syringe-drive systems.
- **Speciation Analysis:** Zero-dead-volume and secure, direct connection for hyphenated techniques, such as LC-ICP-MS, HPLC-ICP-MS, IC-ICP-MS, and FFF-ICP-MS.
- **High-Efficiency Sample Introduction System (HE-SIS):** Connect to Glass Expansion's HE-SIS, which provides up to 95% transport efficiency for a variety of applications.
- **High-Precision Analysis:** Create a high-pressure seal when performing self-aspiration for the most stable sample uptake and delivery.

These easy-to-install kits are completely inert and configured for 1.6 mm (1/16") OD tubing, with PTFE ferrules that reliably seal with all commonly used nebulizer sample tubing materials, such as PFA, PTFE, FEP and PEEK. They provide a secure, zero-dead-volume direct connection to the liquid interface of a Glass Expansion nebulizer.

*The Nexus™ Universal Connection Kit is designed for U-Series (ARG) and DC (A##) nebulizers. It is not compatible with the older EzyFit (AR##) nebulizers.

[Click here](#) to view the Nexus Universal Connection Kit landing page and ordering information.



P/N FT-16-8

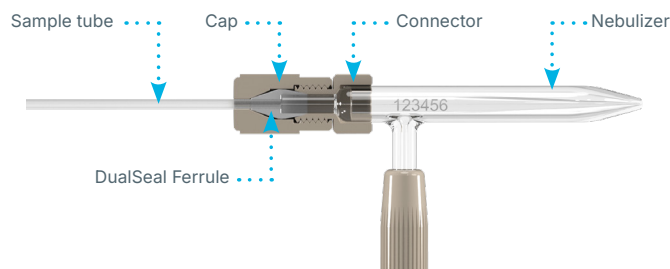

P/N FT-16-8-X

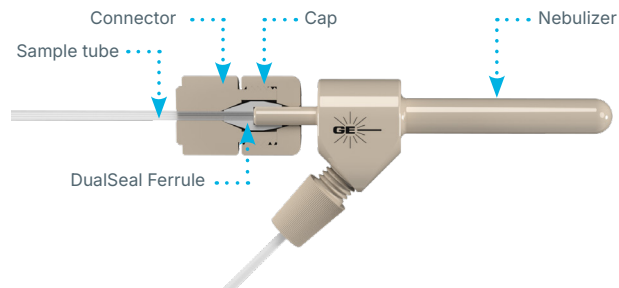

Glass Expansion Trademark Nebulizer Designs

As the nebulizer is a critical component of your ICP-OES and ICP-MS sample introduction system, you need to make the right choice to get the best results out of your instrument. The following details and selection guides for Glass Expansion's high-quality concentric nebulizer designs provide guidance on which nebulizer is best suited to your laboratory's requirements in addition to some common standard testing methods and usage in specific industries. If you have any questions about compatibility please contact Glass Expansion.

SeaSpray Nebulizer - Outstanding Efficiency and Tolerance to Dissolved Solids

- Material: Borosilicate glass
- A high physical reproducibility (1%) guarantees consistent performance of replacement nebulizers, backed by Glass Expansion's Value Proposition (Page 3).
- TDS tolerance, typically up to 20%
- Tolerance to particulates, typically up to 200µm for USS1&2
- Low RSDs due to highly accurate construction
- Lowest dead volume for rapid washout
- Instrument Suitability: used with both ICP-OES and ICP-MS

The SeaSpray nebulizer has the highest sensitivity of any concentric glass nebulizer on the market. Perfect for high concentrations of dissolved solids up to 20%TDS. Common samples include wastewater, seawater, groundwater, surface water, brines, high salt (including Li-ion batteries), soils, sludges and plating baths are just a few examples. A number of ICP-OES instrument manufacturers employ the SeaSpray as part of their standard instrument configuration.

Customer Comment: "It is, without a doubt, the best nebulizer I have ever used-in over 20 years of ICP analysis." Environmental laboratory - Canada



Common standard testing methods include:

- EPA 200.7
- EPA 6010D (SW-846)
- ASTM D1976
- EPA 200.8
- EPA 6020B (SW-846)
- ASTM D5673

MicroMist Nebulizer - The Worldwide Standard for ICP-MS Applications

- Material: Borosilicate glass
- A high physical reproducibility (1%) guarantees consistent performance of replacement nebulizers, backed by Glass Expansion's Value Proposition (Page 3).
- TDS tolerance, typically up to 15%
- Tolerance to particulates, typically up to 100µm
- Low RSDs due to highly accurate construction
- Lowest dead volume for rapid washout
- Instrument Suitability: most commonly used with ICP-MS

When sample volume is limited, the MicroMist nebulizer is ideally suited due to its excellent transport efficiency and precision. It is the worldwide standard for ICP-MS due to its performance at low flow rates. Common samples include drinking water, biological or clinical, precious metals, fine chemicals, volatile solvents, pharmaceuticals, nutraceuticals, radioactive, single-cell, nano particle, microplastics, and cannabis. A number of ICP-MS instrument manufacturers employ the MicroMist as part of their standard instrument configuration.

Customer Comment: "I replaced my cross-flow system with your MicroMist and Cinnabar spray chamber and get much better performance. Also, I am getting the same counts as I was getting on my cross-flow at twice the uptake rate." Environmental service laboratory - USA



Common standard testing methods include:

- EPA 200.8
- EPA 6020B
- EPA 6800
- USP <233>
- ISO 17294-2:2023
- ASTM D5673

Slurry Nebulizer - Ideal for Wear Metals in Engine Oils

- Material: Borosilicate glass
- A high physical reproducibility (1%) guarantees consistent performance of replacement nebulizers, backed by Glass Expansion's Value Proposition (Page 3).
- TDS tolerance, typically ~ 1%
- High tolerance to particulates, typically up to 280µm
- Low RSDs due to highly accurate construction
- Slurry nebulizers have a natural liquid uptake of 4mL/min but operate best between 1.5 and 2.5mL/min
- Instrument Suitability: ICP-OES

The Slurry nebulizer excels at exactly what it sounds like, the analysis of slurries or samples with undissolved particulates. The common sample types include slurries, suspensions, oils (including used engine oil, edible oils, and other oil-based lubricants), and organics such as engine coolants and antifreeze. A number of ICP-OES instrument manufacturers recommend the Slurry for used oils.

Customer Comment: *"The Slurry nebulizer is even more powerful! Photographic emulsions, contain large extents of dissolved, undissolved solids and organics/inorganic salts ... Previously we could analyze only a 1 m/v% diluted photographic emulsion. With this Slurry nebulizer we can analyze a 10 m/v% solution, giving us an improved detection limit of a factor of 8 (corrected on internal standard)."*

Photographic company - The Netherlands



Common standard testing methods include:

- ASTM D5185
- ASTM D6751
- ASTM D7691

Conikal Nebulizer - An Industry Standard Concentric Design

- Material: Borosilicate glass
- A high physical reproducibility (1%) guarantees consistent performance of replacement nebulizers, backed by Glass Expansion's Value Proposition (Page 3).
- TDS tolerance, typically up to 5%
- Tolerance to particulates, typically up to 210µm
- Low RSDs due to highly accurate construction
- Lowest dead volume for rapid washout
- Instrument Suitability: ICP-OES and ICP-MS

The Conikal nebulizer is an exceptional general-purpose nebulizer. The common sample types include aqueous, organics, and oils that do not require a more specialized design for resistance to particulates or high dissolved solids. As a result, a number of ICP-OES instrument manufacturers recommend the Conikal whenever samples contain only a moderate concentration of dissolved salts, no particulates, and no hydrofluoric acid.

Common standard testing methods include:

- ASTM D4591
- EPA 200.7



HE MicroMist Nebulizer - High-Efficiency for Specialized Applications

- Material: Borosilicate glass
- A high physical reproducibility (1%) guarantees consistent performance of replacement nebulizers, backed by Glass Expansion's Value Proposition (Page 3).
- TDS tolerance typically up to 15%
- Low RSDs due to highly accurate construction
- Sample flow range: 0.01 to 0.4mL/min
- Designed gas flow range: 0.2 to 1.0 L/min
- Instrument Suitability: most commonly used with ICP-MS and HE-SIS



A specially designed nebulizer based on our popular MicroMist, designed to efficiently nebulize very small sample volumes at low sample and argon gas flow rates. It is a standard component of the High-Efficiency Sample Introduction System (HE-SIS), widely adopted by leading research organizations and instrument manufacturers for single-cell, single-particle, nanoparticle, and low-volume sample studies, achieving up to 95% transport efficiency when combined with the HE-SIS.

Inert Nebulizers

Nebulizers made of glass or quartz are unsuitable for:

- Ultra-trace ICP-MS determination of some elements such as silicon
- Use with caustic solutions
- Samples containing free-HF acid

For these challenging analyses, a high-quality ceramic or polymeric nebulizer is the best choice. The following guide details Glass Expansion's high-quality inert nebulizer designs and provides guidance on which nebulizer is best suited to your laboratory's requirements.

DuraMist Nebulizer - Versatile High-Performance for High Salt and HF Matrices

- Material: HF Resistant PEEK
- A high physical reproducibility (2%) guarantees consistent performance of replacement nebulizers, backed by Glass Expansion's Value Proposition (Page 3).
- Tolerance to particulates, typically up to 200µm
- TDS tolerance, typically up to 30%
- Low RSDs due to concentric geometry
- Lowest dead volume for rapid washout
- Instrument Suitability: ICP-OES and ICP-MS



The DuraMist™ is one of our most versatile and durable concentric nebulizer designs. Manufactured with a PEEK body and PTFE capillary insert, the DuraMist can handle the toughest acid matrices, including up to 5% Hydrofluoric Acid (HF). A uniquely designed smooth tip provides an outstanding tolerance to total dissolved solids (TDS), up to 30%. It is a great "all-rounder" and the choice for the analysis of diverse sample types. Serviceability is high, as the capillary insert assembly can be replaced if needed.

The DuraMist is ideal for high-throughput labs that require a good balance between durability and sensitivity.

Customer Comment: "The DuraMist Nebulizer performs very well. The Si background is as low as they have ever seen, and the stability of the DuraMist has proven excellent." ICP Company - USA

Common standard testing methods include:

- EPA 200.7
- EPA 6010D (SW-846)
- ASTM D1976
- EPA 200.8
- EPA 6020B (SW-846)
- ASTM D5673

OpalMist Nebulizer - Ideal for High Purity and High Chemical Resistance

- Material: PFA
- A high physical reproducibility (3%) guarantees consistent performance of replacement nebulizers, backed by Glass Expansion's Value Proposition (Page 3).
- Tolerance to particulates, typically up to 200µm for PFA2
- TDS tolerance, typically up to 15%
- Low RSDs due to concentric geometry
- Lowest dead volume for rapid washout
- Instrument Suitability: ICP-OES and ICP-MS

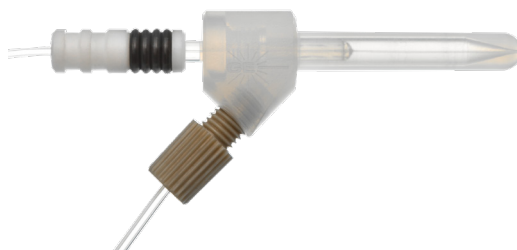

The OpalMist concentric nebulizer is made of ultra-high-purity PFA and is the choice for high-precision analyses and the best chemical resistance to HF, alkalis, and organics. In addition, the high-purity PFA construction results in the lowest elemental background levels, making it ideal for ultra-trace ICP-MS work. OpalMist nebulizers are commonly used for high-purity semiconductor chemicals, isotopic mineral analysis, and geological samples requiring HF digestion. Like the DuraMist, the capillary insert assembly can be replaced if needed.

Customer Comment: "I just replaced my HF spray chamber with yours and used it with your OpalMist nebulizer. I am now getting twice the signal as before and my nebulizer no longer clogs." QC laboratory - USA

Ceramic VeeSpray Nebulizer - A Modern, Robust V-Groove Design

- Material: 99.8% Alumina Ceramic
- A high physical reproducibility (1%) guarantees consistent performance of replacement nebulizers, backed by Glass Expansion's Value Proposition (Page 3).
- TDS tolerance, typically up to 30%
- High tolerance to particulates, typically up to 550µm
- Design uptake range: 0.6 - 3mL/min. Operates best between 1.5 - 2.5mL/min (must be pumped – does not self-aspirate)



The Ceramic VeeSpray is a highly durable, V-groove design, capable of handling high levels of dissolved solids and particulates without clogging. The ceramic body is compatible with all aqueous and organic solvents, including HF. Since the VeeSpray is not a concentric nebulizer and does not self-aspirate the sample, it requires sample delivery via peristaltic pump and operates best at higher sample flow rates (1.5 – 2.5 mL/min) to reduce pulsations.

Customer Comment: "When I was introduced to the GE V-groove I was told it would pass gravel and it did while retaining its performance." Electricity Company - USA

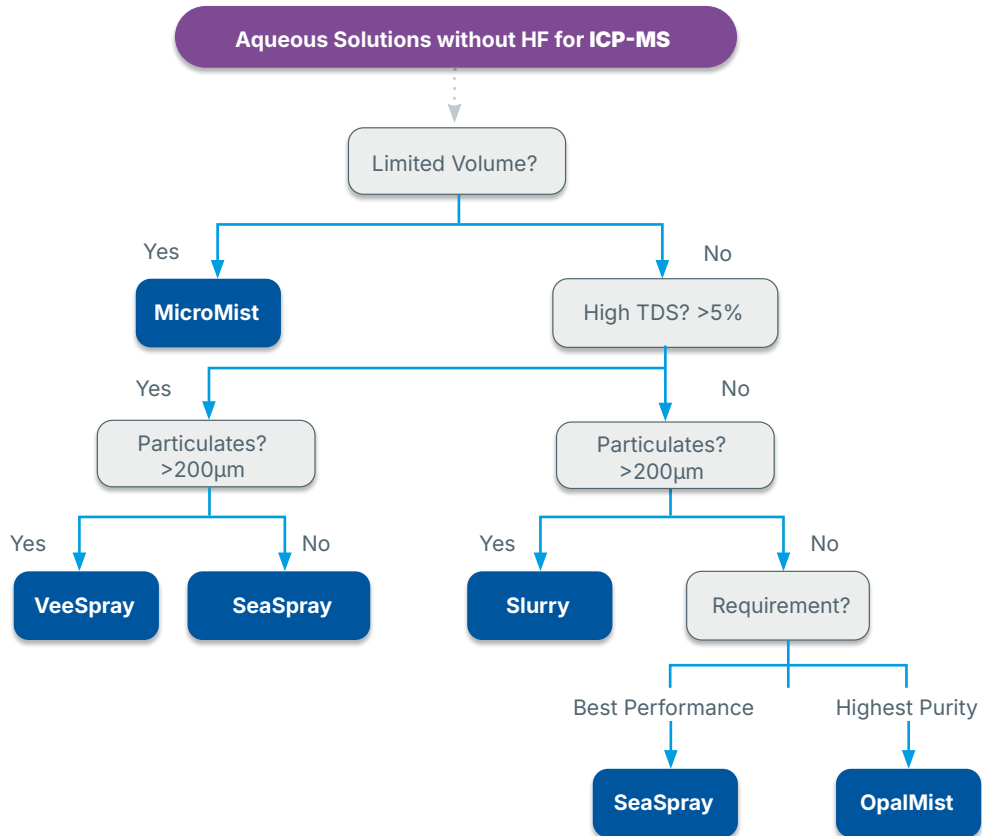
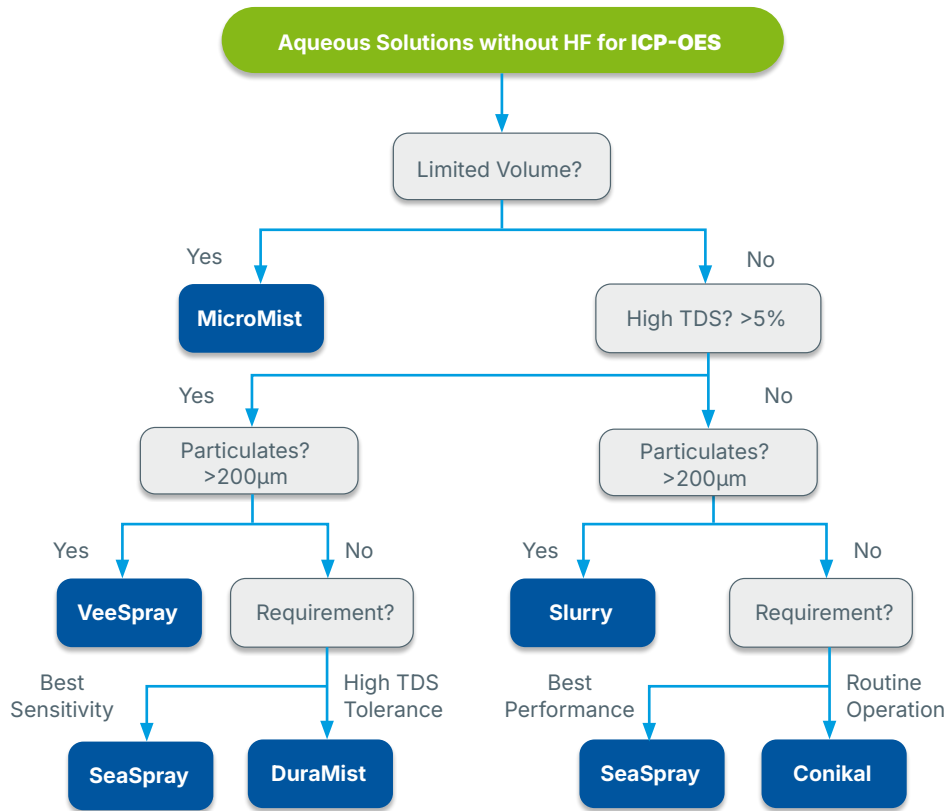

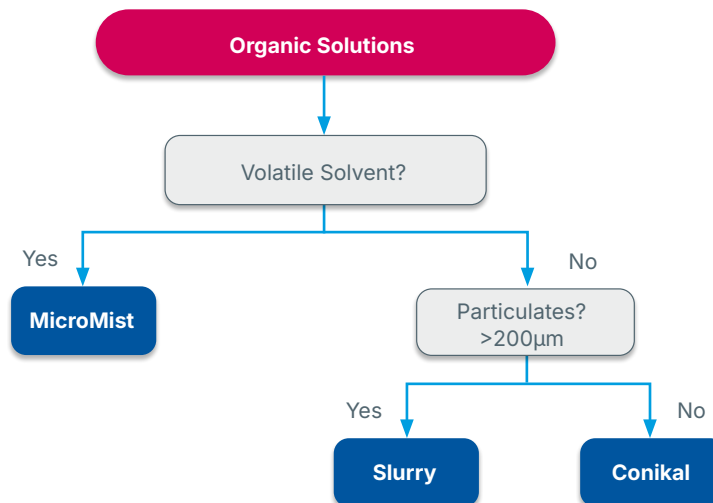
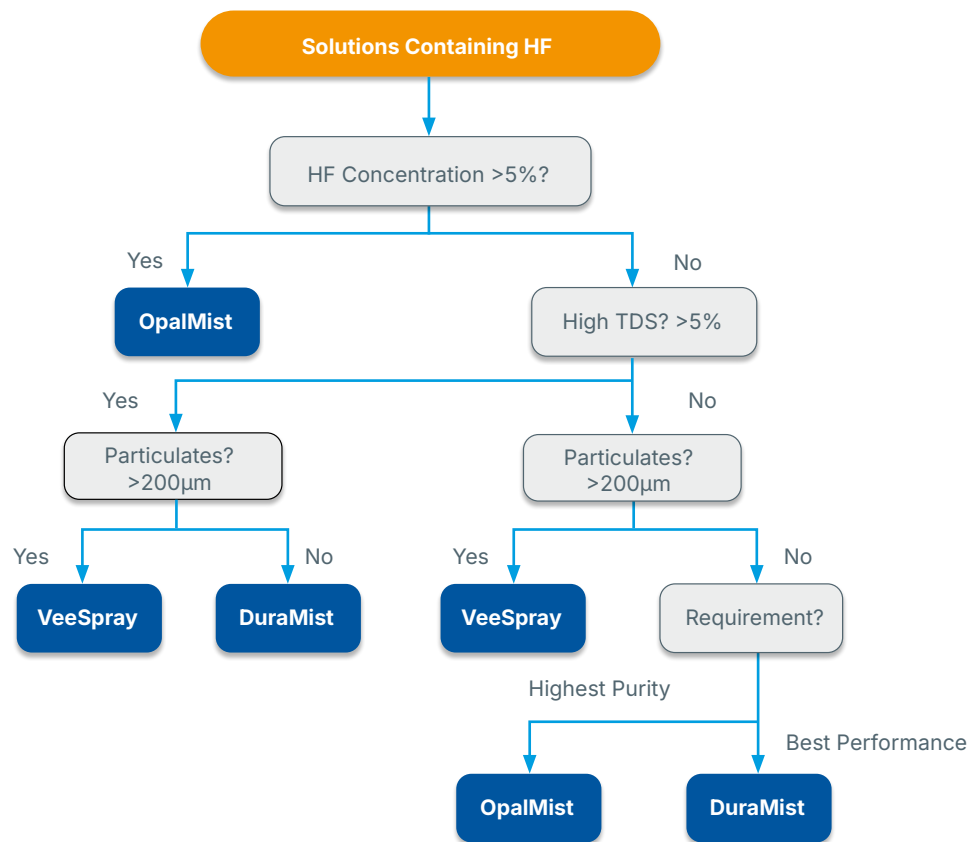

TruFlo Sample Monitor

- Eliminates guesswork
- Reduces sample repeats
- Sounds out-of-range alarm
- Is suitable for all ICP-OES and ICP-MS models

Do you ever need to repeat the analysis of a sample due to:

- A blocked nebulizer?
- Worn peristaltic pump tubing?
- Incorrect pressure of the pump tubing clamp?

With the digital display of the TruFlo Sample Monitor, you always know the actual rate of sample uptake to your nebulizer. This enhances the day-to-day reproducibility of your results and reduces the need to repeat measurements due to a blocked nebulizer, worn pump tubing or incorrect clamping of the pump tube. And the borosilicate glass sample path ensures that there is no memory effect or sample contamination. The TruFlo can even sound an alarm if the sample uptake is outside your specified limits

The actual sample flow is shown on the TruFlo's inbuilt digital display and a graph of the flow versus time can also be displayed on your computer.



[Click here](#) to view the TruFlo Sample monitor landing page and ordering information.



Eluo™ Nebulizer Cleaning Tool

As easy as 1, 2, 3

1. Fill with solvent



2. Attach barrel and insert nebulizer



3. Clean nebulizer



Particle build-up in a nebulizer capillary and tip causes sample flow to be constricted, reducing nebulizer efficiency and performance. Now, blocked nebulizers can be safely and easily restored to optimum performance with a revolutionary cleaning instrument – the Eluo.

The Eluo is designed to efficiently deliver a cleanser through the nebulizer capillary to dislodge particle build-up and thoroughly clean the nebulizer. One simple action does it all. No more messy procedures or shattered nebulizers in ultrasonic baths. Use the Eluo regularly to maintain nebulizer performance and prolong nebulizer life. Every lab should have an Eluo.

The Eluo can also be conveniently used to clean the Inline Particle Filter P/N 70-803-1108 with the addition of Adaptor P/N 70-803-1160.

We have found that using a dilute concentration of Fluka RBS-25 (manufactured by Sigma-Aldrich, and is available from most suppliers of laboratory chemicals) is the best cleaning solution. Stubborn clogs may require an overnight soak or additional cleaning with nitric acid.



P/N 70-ELUO



P/N 70-ELUO-OPD

[Click here](#) to view the Eluo Nebulizer Cleaning Tool landing page and ordering information.



Guardian™ In-Line Sample Filter



P/N 70-803-1108

If there are particulates in your samples, there is a risk that they may get trapped in the narrow bore sample tubing or within the nebulizer. The Guardian In-Line Sample Filter provides a simple and effective way to eliminate this risk. This filter is easily inserted in the sample tubing between the autosampler probe and the nebulizer. It incorporates a 120 micron PolyComb filter and is suitable for use with 1/16 inch (1.6mm) OD or 1.3mm OD sample tubing. When high-throughput valves are in use, the Guardian™ filter can be installed upstream of the valve. This prevents large particulates from entering the valve, which could otherwise score the internal sample path and lead to premature valve failure.

The purpose-built clog-resistant design is ideal for ICP samples. Unlike sintered or frit style filters, the linear honeycomb structure makes the PolyComb filter resistant to clogging from particulates. Any particle build-up is easily removed by back-flushing using the Eluo Adaptor 70-803-1160. And the PEEK material is suitable for use with all of the most common ICP solutions.

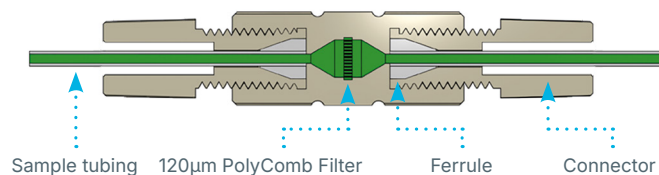

Eluo Adaptor For In-Line Filter
P/N 70-803-1160

[Click here](#) to view the Guardian™ In-Line Filter landing page and ordering information.



Guardian™ In-Line Non-Return Gas Filter



P/N 70-803-1942

The new Guardian In-line Non-Return Gas Filter provides protection for your ICP system in two ways:

1. A non-return valve prevents acidified sample or rinse solution syphoning into the instrument gas box.
2. 30µm PolyComb filter protects the nebulizer from particulates in the instrument gas supply.

The Guardian In-line Non-Return Gas Filter is positioned between the Argon inlet on the Direct Connection nebulizer and the gas supply fitting on the instrument. The In-line Non-Return Filter has a one-way valve that allows argon to flow from the instrument into the nebulizer, but prevents liquid syphoning into the instrument. A unique PolyComb 30µm filter design protects the nebulizer from particulates from the gas supply or from worn or damaged fittings in the gas lines. Unlike Sintered or Frit style filters, the linear honeycomb structure makes PolyComb most resistant to particulate and dissolved solid clogging.

Syphoning of the sample or rinse solution into the nebulizer argon control module on your ICP can occur at the end of an analytical run when the nebulizer gas pressure is turned off and there is liquid in the sample flow path. It is made worse if the autosampler probe stays in the rinse position at the end of a run.

An overlooked issue when using an autosampler for unattended overnight runs is its potential to silently and invisibly damage your ICP instrument. Acidified solution in the instrument's argon control module can corrode electronic sensors in mass flow controllers and damage regulators, leading to costly repairs and unplanned downtime.

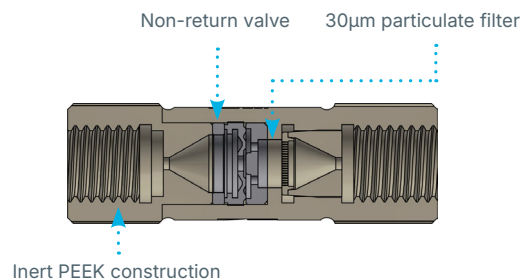

***The Guardian non-return valve is intended for use with gas lines only.**

[Click here](#) to view the Guardian™ In-Line Non-Return Gas Filter landing page and ordering information.



Trident CT™ In-Line Reagent Additions Kits

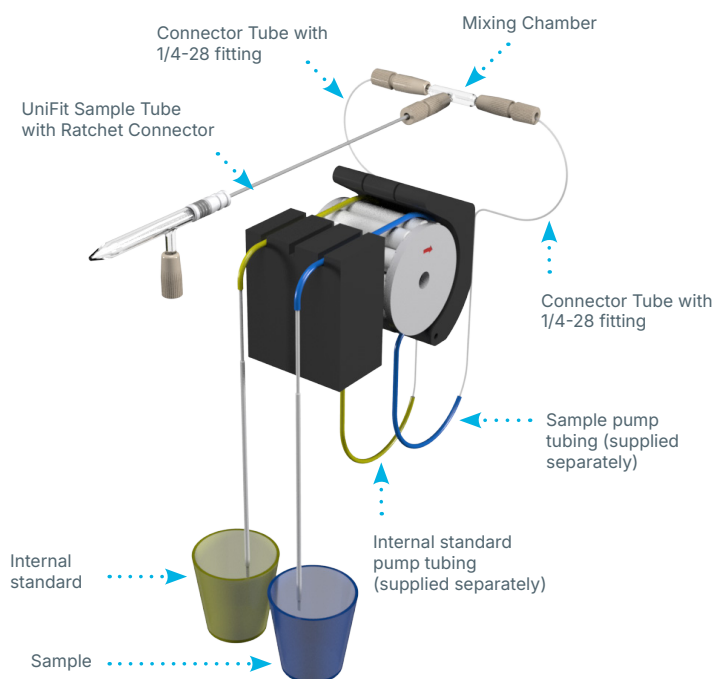

The Trident CT mixing chamber is based on the industry-proven design of the Trident, but with the addition of Glass Expansion's ConstantTorque (CT) to provide a simple-to-use, leak-free connection for both the internal standard and sample, every time.

The heart of the kit is the mixing chamber, designed with zero dead volume CT fittings. With other mixing chambers, worn or improperly fitted connections leak, inject a stream of air bubbles into the nebulizer flow, degrading short-term analytical precision (%RSD). By using CT ratchet-style fittings, the Trident CT eliminates air leaks, optimizing analytical performance.

The Trident CT features:

- Compact, efficient mixing chamber ensures complete mixing of the sample and reagent.
- CT fittings for a durable, leak-free seal on all connections.
- Zero dead volume connections.
- Completely modular so that damaged or lost components can easily be replaced.

Check the Trident Dilution Factor Calculator on our website to find out the sample and internal standard dilution factors for selected combinations of pump tubing.

[Click here](#) to view the landing page and ordering information for the Trident CT™ In-Line Reagent Additions Kits.



Guardian™ Autosampler Probes

The unique design of the robust tip—which combines drip-resistance and built-in particle filtering—helps to prevent cross-contamination during probe movement and blockages in your nebulizer and nebulizer sample tubing. Constructed entirely from Ceramic, PEEK and PTFE, the Guardian autosampler probe also provides exceptional resistance to strong acids and solvents. The Guardian probe has an ID of 1.0mm, with interchangeable UniFit sample capillaries that are available in IDs of 0.3, 0.5, 0.75 and 1.0mm.

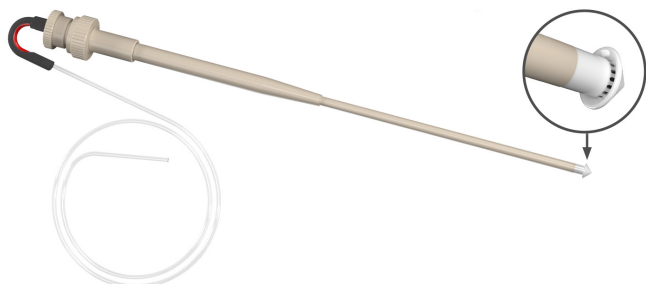

Benefits:

- Proprietary mechanical finish provides superior wetting characteristics.
- Robust tip design prevents crushed and damaged tips due to misalignment.
- Drip-resistance prevents cross contamination of samples, especially with oils.
- Built-in particle filtering holds back particulates from blocking the line.
- Completely inert design, Ceramic, PEEK and PTFE construction.
- Interchangeable UniFit™ sample lines available in various IDs (e.g. 0.3, 0.5, 0.75 & 1.0mm)
- Designed to suit Teledyne Cetac®, Agilent®, PerkinElmer®, Shimadzu®, Aim Lab and Thermo Fisher Scientific™ Autosamplers.

Guardian Probe with Connecting Line (Red)

Guardian Probe for SPS3/SPS4/AIMS, 0.75mm	70-803-1957
Guardian Probe Cetac ASX-200/500/800, 0.75mm	70-803-1803
Guardian Probe Cetac ASX-7400, 7600 Series, 0.75mm	70-803-2940
Guardian Probe for PerkinElmer S20 Series, 0.75mm	70-803-2097
Guardian Probe for PerkinElmer S10, 0.75mm	70-803-2851
Guardian Probe for PerkinElmer AS93, 0.75mm	70-803-2836
Guardian Probe for Shimadzu AS-10 & AS-20 with Arm Assembly, 0.75mm	70-803-2872
Guardian Probe for Thermo iSC-65, 0.75mm	70-803-2106

Probe Connecting Lines for all Autosamplers (excluding ASX-112FR)

Probe Connecting line 1.0mm ID (Green)	70-803-1721
Probe Connecting Line 0.75mm ID (Red)	70-803-1714
Probe Connecting Line 0.5mm ID (Blue)	70-803-1852
Probe Connecting Line 0.3mm ID (Black)	70-803-1853

Guardian Probe only

Guardian Probe for SPS3/SPS4/AIMS	70-803-2008
Guardian Probe for Cetac ASX-200/500/800 Series	70-803-1787
Guardian Probe for Cetac ASX-7400, 7600 Series	70-803-2937
Guardian Probe for Cetac ASX-112FR	70-803-2029
Guardian Probe for PerkinElmer S20 Series	70-803-2754
Guardian Probe for PerkinElmer S10	70-803-2849
Guardian Probe for PerkinElmer AS93	70-803-2819
Guardian Probe for Shimadzu AS-10 & AS-20	70-803-2860
Guardian Probe for Thermo iSC-65	70-803-2837

Probe Connecting Lines for ASX-112FR

Probe Connecting Line 0.18mm ID (Black)	70-803-2030
Probe Connecting Line 0.18mm ID with EzyFit (Green/Black)	70-803-2085

[Click here](#) to view the Guardian™ Autosampler Probe landing page, ordering information, and comparison videos.



Elegra™ Argon Humidifier

To Spectrometer gas port
 To Nebulizer
 Gas Inlet
 Gas Outlet



An Argon Humidifier is commonly used in ICP analyses involving samples with high concentrations of dissolved solids. It helps to alleviate salt deposits in the nebulizer and torch injector, allowing uninterrupted and maintenance-free operation.

- Compact, cost-effective design.
- No heating or electric power required.
- Non-pressurized water reservoir.
- An easy-to-use bypass switch allows you to take the Elegra off-line without disconnecting argon lines. (Not available with Elegra Dual)
- Highly efficient membrane humidification technology.
- Improved signal stability for samples with high TDS.
- Simple to install, use and maintain.
- Improves productivity by reducing down-time for cleaning.
- Inert metal-free construction eliminates contamination.
- Maximum and minimum fill marks ensure that you are always operating under optimum conditions.
- Compatible with all ICP-OES and ICP-MS models. Direct connection to argon outlet provided for most models.
- Elegra Dual configuration available for ICP-MS instruments using auxiliary argon.

[Click here](#) to view the Elegra™ landing page and ordering information.



Magnifier Inspection Tool

It is good practice to regularly inspect for wear and tear in your nebulizer tip, nebulizer sample tubing, and ICP-MS interface cones. This critical process can now be completed in-house and confidently with the Glass Expansion Magnifier Inspection Tool.



P/N 70-803-1923

The Magnifier Inspection Tool features:

- 10X Magnification
- 8 LED Lights
- Manual Focus Knob
- 20mm Glass Reticle Horizontal Scale
- Protective storage pouch

Nebulizer Blockages: Nebulizer blockages generally occur at the tip and can be difficult to spot, but with the Magnifier Inspection Tool, you can check for foreign objects or a build-up of salt around the tip orifice.

ICP-MS Cone Condition: The condition of your interface cones is critical to the analytical performance of your ICP-MS. Simply use the Magnifier Inspection Tool to check the cone orifice for pitting, matrix build-up, or an enlargement of the orifice. It is also a great way to evaluate the effectiveness of your cleaning procedure before reinstalling the interface cones.

Nebulizer Sample Tubing: At 10X magnification with LED illumination, nebulizer sample tubing can be carefully inspected for a partial blockage. Partial blockages are often the source of erratic analytical performance due to increased sample back pressure and poor nebulization.





Nebulizer Troubleshooting Guide

Symptom / Issue	Potential Cause (s)	Corrective Action (s)	Preventative Measures
High Nebulizer Backpressure	<ul style="list-style-type: none"> Blocked or clogged nebulizer due to salt deposits, particulates, or dried residues from high TDS samples 	<ol style="list-style-type: none"> Clean nebulizer as described on Page 20 If cleaning fails to restore performance, use Magnifier Inspection Tool (Page 17) to check for damage; replace nebulizer if necessary 	<ul style="list-style-type: none"> Start and finish each run by nebulizing a mildly acidic rinse solution, followed by deionized water for 5 to 10 minutes to prevent deposits. Dilute Fluka RBS-25™ can be used for more stubborn matrices (see Page 20) Employ accessories such as the Elegra™ Argon Humidifier to prevent salt buildup (see Page 17) For particulate blockages, install Guardian™ In-Line Sample Filter (Page 15) or Guardian™ Autosampler Probe (Page 16) to prevent particulate blockages Verify nebulizer compatibility (see table on Page 1 and selection guide on Pages 11 and 12)
Low Nebulizer Backpressure (often coupled with a loss in sensitivity)	<ul style="list-style-type: none"> Gas leak in tubing connections or fittings Nebulizer damage (e.g., cracks, breakage, or wear) Kinked or fatigued tubing 	<ol style="list-style-type: none"> Check argon gas connections at instrument and nebulizer arm for leaks; soapy water can be used to assist Inspect nebulizer for visible cracks or damage using Magnifier Inspection Tool (see Page 17); replace nebulizer if necessary Replace damaged tubing or fittings; use Direct Connect (DC)™ fittings for secure, kink-resistant connections If using a DC nebulizer, ensure both ratchet fittings are fully tightened, tighten until you hear a click 	<ul style="list-style-type: none"> Regularly inspect connections during routine maintenance Record benchmark backpressure (e.g., 40 PSI / 275 kPa at specified nebulizer flow rate – such as 0.7 or 1.0 L/min) after warm-up and monitor deviations Upgrade to a Direct Connect (DC)™ nebulizer design for improved and more reliable gas connection (Page 4 and 5)
Poor Sensitivity or Loss of Signal	<ul style="list-style-type: none"> Partial blockage Gas flow issues Poor seal in spray chamber Improper nebulizer installation within the spray chamber Wrong nebulizer for sample type 	<ol style="list-style-type: none"> Verify nebulizer backpressure <ul style="list-style-type: none"> Refer to High Nebulizer Backpressure and Low Nebulizer Backpressure sections above Check installation of nebulizer within spray chamber; if loose, replace seal If issue persists, inspect spray chamber for efficient draining and proper wetting; clean if necessary Verify nebulizer compatibility; see table on Page 1 and selection guide on Pages 11 and 12 	<ul style="list-style-type: none"> Regularly inspect all connections and seals during routine maintenance Verify nebulizer compatibility; see table on Page 1 and selection guide on Pages 11 and 12 Upgrade to GE Helix CT™ spray chamber for improved nebulizer installation and overall performance Follow nebulizer maintenance guidelines (Page 20)

Nebulizer Troubleshooting Guide

Symptom / Issue	Potential Cause (s)	Corrective Action (s)	Preventative Measures
Erratic or Poor Precision (high RSDs)	<ul style="list-style-type: none"> Blocked or damaged nebulizer Unstable gas flow Worn peristaltic pump tubing Poor draining or wetting in the spray chamber Poor nebulizer seal in the spray chamber Improper nebulizer installation within the spray chamber Sample carryover, blocked or old autosampler probe. 	<ol style="list-style-type: none"> Refer to previous troubleshooting sections <ul style="list-style-type: none"> High Nebulizer Backpressure Low Nebulizer Backpressure Poor Sensitivity If nebulizer appears to be working optimally, check other components of the sample introduction system for cleaning or replacement (e.g., spray chamber) Replace pump tubing; check tension on clamps Ensure method settings (such as rinse and stabilization times) are appropriate. Inspect, clean, and replace autosampler probe as necessary. 	<ul style="list-style-type: none"> Regularly inspect fittings, connections, and tubing; replacing or upgrading a necessary Employ TruFlo™ to check clamp dimensions and monitor flow rate changes (Page 13) Install appropriate accessories, such as the Elegra™ Argon Humidifier (Page 17), Guardian™ In-Line Sample and/or Gas Filter (Page 14), and Guardian™ Probe (Page 16) to match sample matrix requirements Adjust method settings and parameters depending on sample matrix and analytical requirements
No Aerosol Production	<ul style="list-style-type: none"> Complete blockage in nebulizer, nebulizer sample tubing, valve, or autosampler probe Disconnected/leaking gas or sample lines Damaged nebulizer 	<ol style="list-style-type: none"> Verify sample and gas supply settings In a step-by-step manner, identify presence and location of blockage; clean or replace as needed <p><i>Note: A good troubleshooting tip is to first replace with a known working nebulizer to determine if it is a nebulizer issue or if the issue is further upstream.</i></p> <p><i>If the "test" nebulizer works immediately, the non-aspirating nebulizer is clogged and should be cleaned as described on Page 20.</i></p>	<ul style="list-style-type: none"> Regular cleaning and inspection of system components Install appropriate accessories, such as the Elegra™ Argon Humidifier (Page 17), Guardian™ In-Line Sample and/or Gas Filter (Page 14), and Guardian™ Probe (Page 16) to match sample matrix requirements Store nebulizers properly to avoid damage to the tip. Glass Expansion nebulizers are all shipped with a reusable and ideal protective plastic storage case
Physical Damage or Breakage	<ul style="list-style-type: none"> Mishandling Incompatible materials (e.g., glass nebulizer with HF) Improper cleaning or storage 	<ol style="list-style-type: none"> Only clean nebulizer as described by manufacturer. For guidance on Glass Expansion nebulizer maintenance, see Page 20. Aggressive acids, like HF, require inert materials, such as PFA (Glass Expansion's OpalMist™ nebulizer) or PEEK (Glass Expansion's DuraMist™ nebulizer) <p><i>Note: Glass nebulizers should NOT be sonicated, as this may cause the capillary to break.</i></p>	<ul style="list-style-type: none"> Verify nebulizer compatibility; see table on Page 1 and selection guide on Pages 11 and 12 Upgrade to a Helix CT™ spray chamber to avoid bondage in the case of an O-ring seal or deformation due to overtightening in the case of a non-GE locking screw Store nebulizers properly to avoid damage. Glass Expansion nebulizers are all shipped with a reusable and ideal protective plastic storage case

Care of Nebulizers

Handling, Storing and Transporting Nebulizers

Apart from the DuraMist, OpalMist and VeeSpray nebulizers, all Glass Expansion concentric nebulizers are made from borosilicate glass or quartz, so you should exercise the same care that you would normally use for glass labware. Treat glass with the care that is due to a brittle material. Glass can fracture and produce sharp, cutting edges, so handle all glass objects with slow, deliberate movements and don't apply large mechanical forces to them.

Take safe care of the nebulizer tips. Don't knock the tip of the nebulizer or leave it unprotected when not in use. Once a nebulizer tip has been damaged, the nebulizer's performance cannot be restored. All Glass Expansion nebulizers are supplied in specially designed plastic boxes. The nebulizer should be kept in this box when it is being stored. This prevents damage to the nebulizer tip, and small particles from lodging in the nebulizer bore and causing blockages.



Daily Maintenance

Always start and finish the use of a nebulizer by nebulizing a mildly acidic blank solution followed by demineralized water for a couple of minutes. This ensures that sample deposits or crystals don't form inside a nebulizer when the solvent inside the nebulizer dries out. Don't wash nebulizers in an ultrasonic bath.

If a concentric nebulizer's sample capillary becomes blocked, use the Eluo nebulizer cleaner to clean and unblock the nebulizer. For the OpalMist and DuraMist nebulizers, use the Eluo HF cleaner (P/N 70-ELUO-OPD). For glass concentric nebulizers, use the standard Eluo nebulizer cleaner (P/N 70-ELUO). The Eluo can also be used regularly to clean and maintain the nebulizer. Nebulizer blockages generally occur at the tip and can be difficult to spot. We recommend using the Magnifier Inspection Tool (P/N 70-803-1923) to check for foreign objects, or a build-up of salt around the tip orifice.

Handy Tips

If you find that RSDs are getting worse, but the spray chamber doesn't seem to be at fault, remember to check the vital argon connection to your nebulizer. Tygon or other polymer tubes can sometimes harden over time and lose their flexible gas-tight grip. A small argon leak at this point can often be located by using a meter of soft silicone tube as a stethoscope. Even a 1% loss of argon can produce changes of several percent in many ICP analytical lines. Check the nebulizer uptake too, for possible ingress of small amounts of air.

If you want to know sample uptake, but don't have all the gear to make a weight-loss or volume-loss check, check the speed of a bubble in your uptake tube over a 10cm length. For a 1.0mm ID tube, an air-bubble transiting 10cm in 10 seconds means that your uptake is 0.47mL/min. An air bubble moving at the same speed in a 0.5mm ID uptake tube (a common dimension with GE's nebulizers) means that the uptake is 118 μ L/min.

Nebulizer Sample Tubing

Nebulizer sample tubing can often be a source of erratic results when undissolved material in your sample solutions cause a partial blockage, increasing sample back pressure and poor nebulization. At 10X magnification with LED illumination, the small nebulizer sample tubing can be carefully inspected using the Magnifier Inspection Tool (P/N 70-803-1923) for peace of mind.

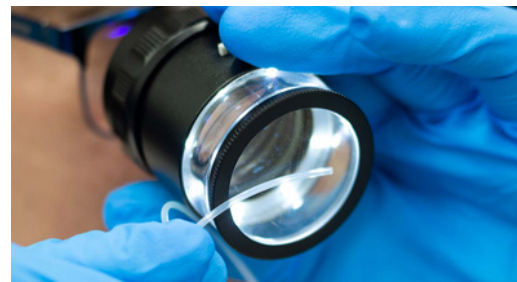

Recommended Cleaning Procedure

If there are salt deposits that cannot be removed with the Eluo, we recommend the following procedure:

1. Initially flush your nebulizer with warm water using the Eluo.
2. Soak the nebulizer tip in a 25% solution of Fluka RBS-25 for 24 hours. Use the Eluo to make sure the Fluka solution fills the nebulizer. An initial flush of 25% Fluka using the Eluo may be required.
3. Flush 3 times with warm water using the Eluo.
4. Stubborn deposits may require an additional soaking for 2 hours with nitric acid (5% concentration).
5. Flush 3 times with warm water using the Eluo.
6. For faster drying, flush again with methanol or isopropyl alcohol.

Tips

- Do not attempt to unblock nebulizers with wires or probes. This is quite likely to damage the nebulizer.
- Do not clean nebulizers in an ultrasonic bath.
- Do not use hot water when cleaning OpalMist or DuraMist nebulizers.
- Never touch the nebulizer tip. Any deposit of body oils can have a detrimental effect on the performance of the nebulizer.

DC Nebulizer Gas Fitting Connectors

Agilent® 4100/4200	70-803-0969
Agilent® Vista/700-ES	70-803-0969
Agilent® 7700/7800/7900/8800/8900	70-803-1105
Agilent® 5100/5110/5800/5900	70-803-1105
Analytik Jena® ICP-MS	70-803-2002
Analytik Jena® ICP-OES	70-803-1105
Horiba® Jobin Yvon (All models)	70-803-1105
Leeman (All models)	70-803-0969
Nu Instruments ICP-MS	70-803-1858
Nu Instruments TOF-ICP-MS	70-803-2044
PerkinElmer® Optima and Avio	70-803-1070
PerkinElmer® Elan/NexION 300/350	70-803-1049
PerkinElmer® NexION 1000, 1100, 2000, 2200, 5000	70-803-1449
Shimadzu® (All models)	70-803-1311
Spectro™ (All models)	70-803-1070
Standard BioTools™ Helios	70-803-1070
Thermo Scientific™ PRO, 6000/7000, Q/RQ/TQ, X-Series & Neoma	70-803-1105
Thermo Scientific™ MX Series	70-803-1105
Thermo Scientific™ Neptune	70-803-0969
Elegra to DC Nebulizer	70-803-1278
ICP Gas Inlet Fitting Type 11/61	70-803-1934
ICP Gas Inlet Fitting Type 13/31	70-803-1504
ICP Gas Inlet Fitting Type 21	70-803-1069
ICP Gas Inlet Fitting Type 22	70-803-2110
ICP Gas Inlet Fitting Type 23	70-803-2111
ICP Gas Inlet Fitting Type 41	70-803-1562
ICP Gas Inlet Fitting Type 51	70-803-1857
ICP Gas Inlet Fitting Type 52	70-803-2048
ICP Gas Inlet Fitting Type 70	70-803-2084

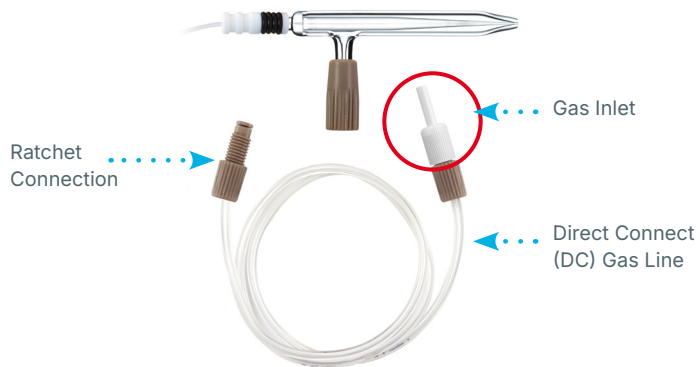

DC Nebulizer Gas Fitting

Nexus Universal Nebulizer Connection Kit

Nexus Universal Nebulizer Connection Kit (Suitable for DuraMist, OpalMist and glass concentric nebulizers) FT-16-8-X

Nexus Universal Nebulizer Connection Kit (Suitable for all glass concentric nebulizers) FT-16-8

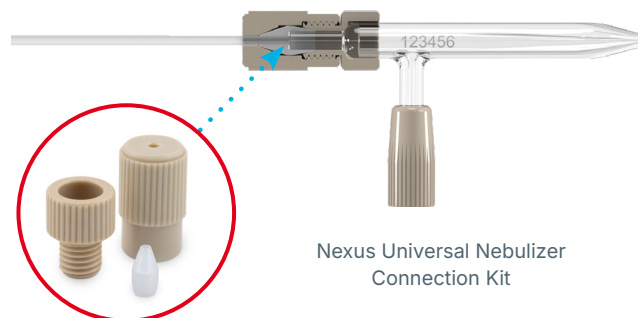

EzyLok Kit for Nebulizer Gas Side Arm

EzyLok Kit EL-1

Comprises:

EzyLok Connector for 4mm Tubing QSM-4
 EzyLok 6mm Hose Adaptor 70-808-0735
 Hose Clip, 6mm SNP-1

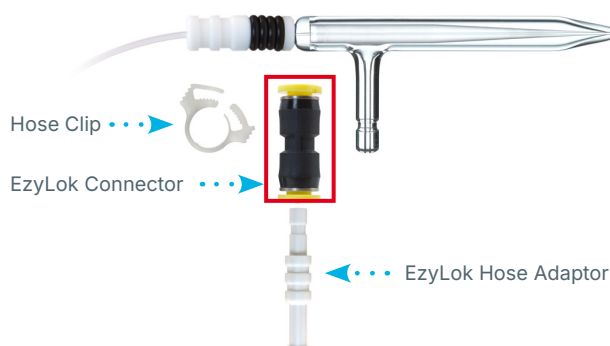

Tubing Connector

1.3mm to 1/16 inch
1/16 inch to 1/16 inch

FT-16-1.3
FT-16-1.6



Tubing Connector 1.3mm to 1/16 inch

PTFE Sample Tubing

0.25mm ID x 1/16" OD x 10m long	STT-16-25
0.50mm ID x 1/16" OD x 10m long	STT-16-50
0.75mm ID x 1/16" OD x 10m long	STT-16-75
1.0mm ID x 1/16" OD x 10m long	STT-16-100
0.07mm ID x 1/16" OD x 10m long	PFT-16-07
0.13mm ID x 1/16" OD x 10m long	PFT-16-13
0.18mm ID x 1/16" OD x 10m long	PFT-16-18
1/8" ID x 1/4" OD x 1m long	1/4PFA-HW

UniFit Connectors (PKT 10)

0.07mm ID x 1/16" OD x 700mm long	NFT-16-07
0.13mm ID x 1/16" OD x 700mm long	NFT-16-13
0.18mm ID x 1/16" OD x 700mm long	NFT-16-18
0.25mm ID x 1/16" OD x 700mm long	NFT-16-25
0.25mm ID x 1/16" OD x 1500mm long	NFTS-16-25
0.75mm ID x 1/16" OD x 700mm long	NFT-16-75
0.75mm ID x 1/16" OD x 1500mm long	NFTS-16-75



UniFit
with sample tube

Other Tubing

Reagent tube 1.6mm OD x 1.0mm ID x 1400mm long with PTFE Sinkers (PKT. 3)	70-803-0752
--	-------------



Reagent tube with
PTFE Sinkers

UniFit™ Flangeless Connectors for High Throughput Valves

These UniFit Flangeless Connectors are designed to connect any Glass Expansion U-Series or DC type trademark nebulizer directly to the most common types of high throughput OEM valve system. Each connector features an optimized inner diameter (ID) and length to minimize the sample path, uptake time, and stabilization time.

P/N **70-803-2882**: Nebulizer Connector UniFit - 1/4-28 Flangeless, 0.25mm ID x 300mm



P/N **70-803-2841**: Nebulizer Connector UniFit - 1/4-28 Flangeless, 0.25mm ID x 140mm



Benefits of UniFit Flangeless Connectors:

- Completely inert (metal-free) assembly.
- Secure UniFit connection to the Glass Expansion nebulizer sample inlet.
- Ratchet style fitting provides a torque-controlled seal to the nebulizer port on the valve.
- Optimized ID and length to minimize sample path, uptake time, and stabilization time.

UniFit Flangeless Connector Compatibility:

The table below lists the most common recommendations based on the OEM valve and ICP model. If your ICP or OEM valve is not listed in the table below please contact Glass Expansion and we can help you find the most suitable connector for your setup or we can create a new product to suit your needs.

Compatibility Chart	
UniFit Flangeless Connector	Recommended ICP
70-803-2841	PerkinElmer® NexION® 1000/2×00/5000
70-803-2842	PerkinElmer® Avio® 2×0/5×0, Optima™, & NexION® 300/350
70-803-1888	Agilent® 5000 Series ICP-OES (with AVS 6/7)
70-803-2882	Agilent® ICP-MS (with prepFAST or FAST – 30 cm)
70-803-2883	Agilent® ICP-MS (with prepFAST or FAST – 50 cm)
70-803-1161	Agilent® ICP-MS (with PCC & AVS MS or ADS 2)
70-803-2882	Thermo™ Fisher Scientific Q/RQ/TQ & MX ICP-MS (with prepFAST or FAST)



Asia Pacific

6 Central Boulevard
Port Melbourne
Vic 3207, Australia

Telephone: +61 3 9320 1111
Email: enquiries@geicp.com

Europe

Friedenbachstrasse 9
35781 Weilburg
Germany

Telephone: +49 6471 3778517
Email: gegmbh@geicp.com

Americas

31 Jonathan Bourne Drive, Unit 7
Pocasset, MA 02559, USA

Toll Free Phone: 800 208 0097
Telephone: 508 563 1800
Facsimile: 508 563 1802
Email: geusa@geicp.com

April 2026